

USER GUIDE

AIR MINDER PLUS

LET YOUR HOME BREATHE



INDOOR AIR QUALITY/HEAT RECOVERY WHOLEHOUSE
VENTILATION SYSTEMS FROM

Vent-Axia[®]

IMPORTANT: TO BE LEFT WITH END USER

AIR MINDER PLUS

LET YOUR HOME BREATHE

CONTENTS

Introduction	Pg 1
Wholehouse Heat Recovery unit	Pg 2
1: Screen Displays	Pg 3
2: Boost Speed Override (Manual)	Pg 4
3: Settling The Controller Clock	Pg 5
4: Adjusting Medium Speed Running Time	Pg 6 - 7
5: Adjusting The Summer Bypass Indoor Comfort Level	Pg 8 - 9
<small>(This facility is only available on certain models)</small>	
Routine Inspection and Maintenance	Pg 9

AIR MINDER PLUS

LET YOUR HOME BREATHE

Dear User.

Thank you for choosing the Vent-Axia Air Minder Plus Wholehouse Ventilation System with Heat Recovery. The system is designed to improve the air quality of your home, whilst reducing the effects of condensation.

The system provides continuous ventilation to the whole property. Extracting stale moist air from the kitchen and bathrooms, whilst simultaneously supplying fresh tempered air to your bedrooms and living rooms. As the stale air is extracted, the heat exchanger within the unit retains 90% of the heat and transfers it to the supply air, thus giving continuous air circulation with minimal heat loss.

Your Air Minder Plus comes complete with a digital controller that continuously shows you the status of the unit, displaying the time and the speed, e.g. medium day time speed or low night time speed.

If your installation requires different settings, refer to section 4 for set up procedures.

Boost speed: On the right hand side of the controller is a boost button, this can be used to change the unit to high speed when extra ventilation is required. The unit will revert back to its normal speed at the next time change interval, or alternatively you can change it back by depressing the button again.

Defrost Mode: If the external air drops below -1°C, to reduce the risk of frost forming on the heat exchanger the defrost mode is activated, this allows the supply fan to stop until the external temperature rises, the extract fan continues to run to allow the internal air to pass a small amount of heat over the exchanger. In installations where a negative pressure is not permitted, your installer will have to set the Air Minder Plus to leave the incoming fan on during defrost mode and open the bypass instead.

Heating Failure: If for any reason the heating system in your house fails and the internal temperature drops below 5°C the unit will stop running so as to not bring cold air into an already cold house. Your unit will start up every 60 mins and will run for a short time to measure the temperature of the property. Once the temperature rises eg: the heating system is switched back on the unit will restart and continue its normal operation.

Filter Check Once every 3 months your controller will display the words 'check filter', when this occurs the filters should be checked and if necessary cleaned or replaced. After the filter has been checked the timer on the controller needs to be reset, this can be achieved by pressing and holding down the 'A' and 'V' keys for 10 seconds.

For AM290FB and AM375FB models only.

Summer Bypass: The Bypass damper activates when the outside air temperature is equal to or below the pre-set '**Comfort Temperature**' (adjustable between 16° and 30°C). The unit's internal damper opens allowing the cooler fresh air from the outside to bypass the Heat Recovery Cube and reduce the internal temperature to the required pre-set '**Comfort Temperature**'.

When the inside air temperature reaches the pre-set 'Comfort Temperature' the Bypass Damper closes.

Thank you for choosing Vent-Axia Air Minder Plus!

Vent-Axia®

AIR MINDER PLUS

WHOLEHOUSE HEAT RECOVERY UNIT

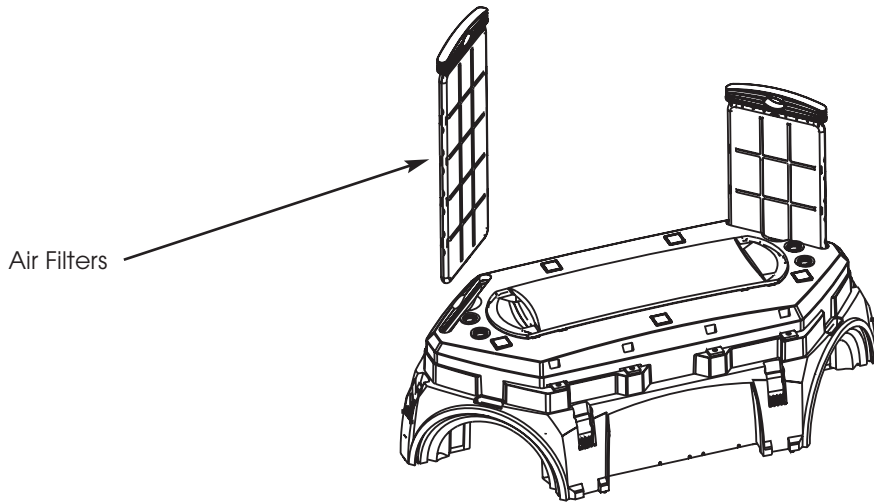

Air Filters

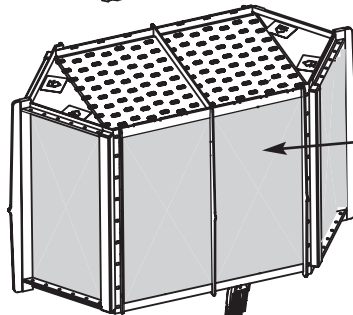

Unscrew the screws on the side of the Heat Recovery Cube and remove the Cube.

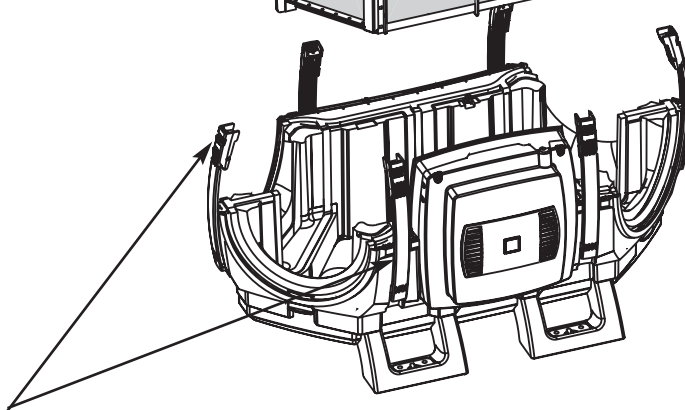

Six yellow Locking Straps

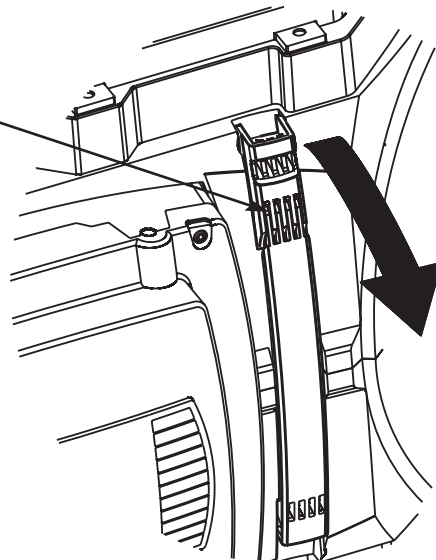

Release the Locking Straps and lift the Top Housing away from the Base Housing to gain access to the Heat Recovery Cube.

AIR MINDER PLUS

1: SCREEN DISPLAYS

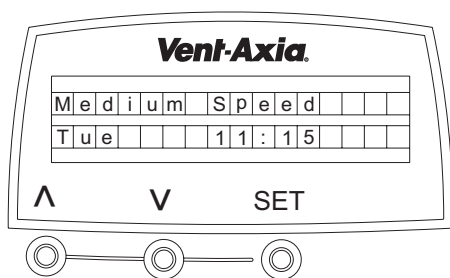

1:1 Normal Running Mode (Daytime Running shown).

Typical Displays:

Daytime: Medium Speed: **On 06:00 / Off 22:30**
Night Time: Low Speed: **On 22:30 / Off 06:00**

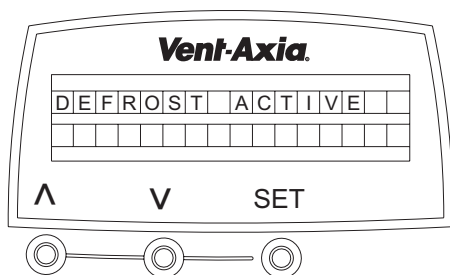

1:2 Defrost Mode

When the external intake air temperature is between 0°C and -5°C the defrost mode will automatically activate. This mode will reduce the supply airflow rate and increase the extract airflow rate to prevent frost forming on the heat exchanger.

When the external intake air temperature is below -5°C the defrost mode will automatically activate. This mode will automatically switch off the supply fan, the extract fan will continue to run at a reduced rate to prevent frost forming on the heat exchanger.

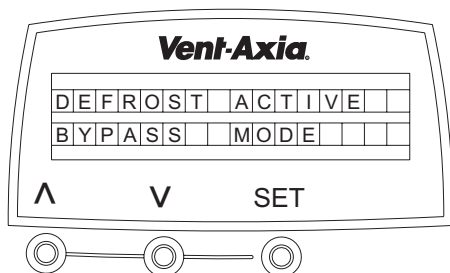

1:3 Defrost Bypass Mode (AM290FB & AM375FB models only)

The intake air temperature has fallen to -1°C or below.

A Damper within the Heat Recovery Unit has opened to bypass the heat recovery cube, when the intake air temperature rises above 0°C the damper will close and normal running mode will resume.

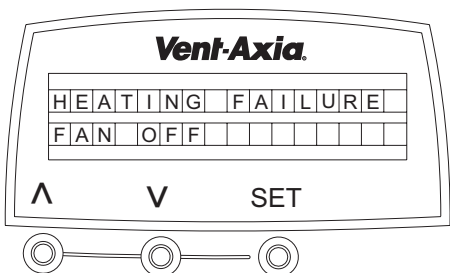

1:4 Heating Failure (Protective) Mode **FLASHING** (Activates in the event of central heating failure).

When the heating system in the dwelling fails to maintain an internal temperature of 5°C. (e.g. Boiler failure), the Heat Recovery Unit will automatically switch off and 'Heating Failure' will be displayed on the controller.

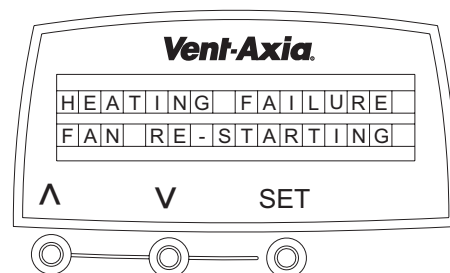

1:5 Central Heating Failure (Fan Re-Starting) Mode **FLASHING**

The Heat Recovery Unit will continue to attempt to re-start by checking the internal temperature for a 10 minute period every 60 minutes. When the Extract temperature rises above 5°C the unit will revert back to normal running mode.

AIR MINDER PLUS

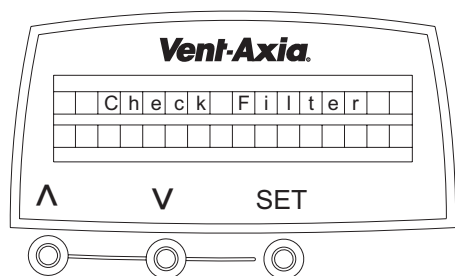

1:6 Filter Check

(Alternates every 3 seconds with 1:1 display).

Filter inspection required of the Intake and Extract Filters.

The Heat Recovery Unit's filters will require regular inspection and cleaning. (Refer to the Heat Recovery Unit's fitting and wiring instructions).

To reset the automatic reminder, press and hold down the 'Λ' and 'V' keys for 10 seconds.

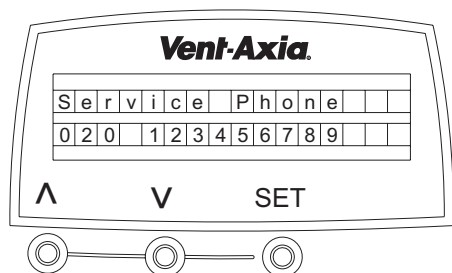

1:7 System Failure

If a fault is found then the Air Minder Plus is turned off and the service telephone number shown; alternating with the Fault code number.

Fault code number

- 1= Intake Fan not running
- 2= Exhaust Fan not running
- 3= Neither Fan running

Add

- 8 = Temperature Sensor T1 faulty
- 16 = Temperature Sensor T2 faulty

For example, a fault code of 10 indicates both Exhaust Fan and Temperature Sensor T1 at fault. For assistance contact your installer or service provider and quote the Fault code number.

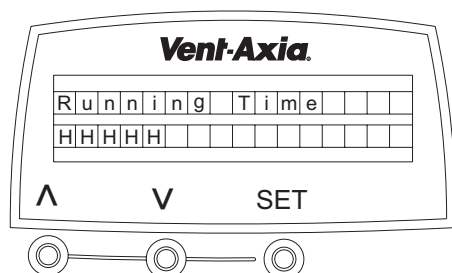

1:8 System Running Time

To display the Total Running Time (Hours). Press and hold the 'Λ', 'V' and 'SET' Keys for 5 seconds. The display will return to normal running display after 10 seconds.

Note:

The timer cannot be re-set. In the event of power failure total time will be retained.

2: BOOST SPEED OVERRIDE (MANUAL)

Default Setting

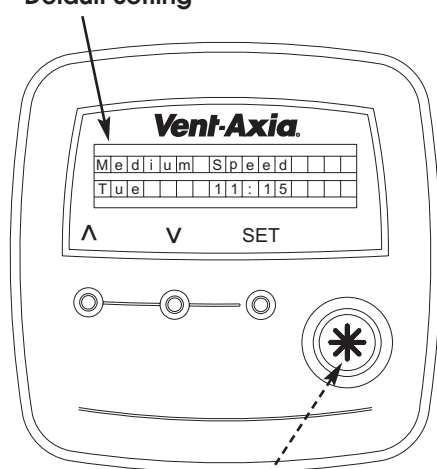

- 2:1. Press the 'Boost Key' to override the current speed setting (Low or Medium depending on the Time Cycle).

The display will change from the default setting to the screen below:

B	o	o	s	t		S	p	e	e	d			
T	u	e				1	1	:	1	5			

- 2:2. Press the 'Boost Key' again and the controller will return the current speed setting (Low or Medium depending on the Time Cycle).

M	e	d	i	u	m	S	p	e	e	d			
T	u	e				1	1	:	1	5			

Note:

If the 'Boost Key' is not pressed to return the speed to the current setting, the speed will return to default speed at the next change of the time cycle.

AIR MINDER PLUS

3: SETTING THE CONTROLLER CLOCK

3:1 When the controller is initially connected to the unit, the following display will appear:

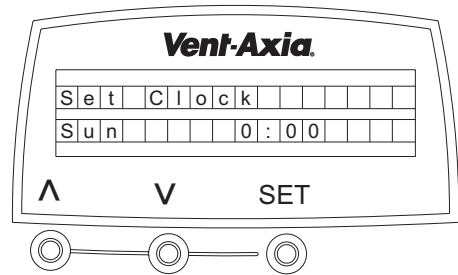

3:2 Setting the Day

Press the 'Λ' or 'V' Key to select the day.

Press the 'Set' Key, and the day is set and the hour will start to flash.

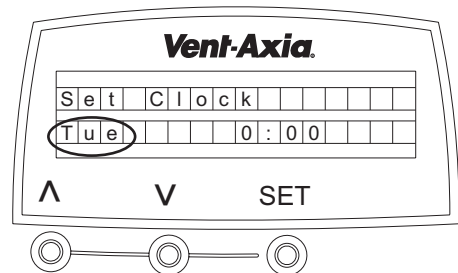

3:3 Setting the Hour

Press the 'Λ' or 'V' Key to select the hour.

Press the 'Set' Key, and the hour is set and the minutes will start to flash.

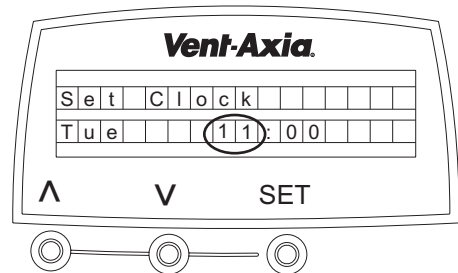

3:4 Setting the Minutes

Press the 'Λ' or 'V' Key to select the minutes.

Press the 'Set' Key, and the minutes are set and the display will scroll to the next setting screen.

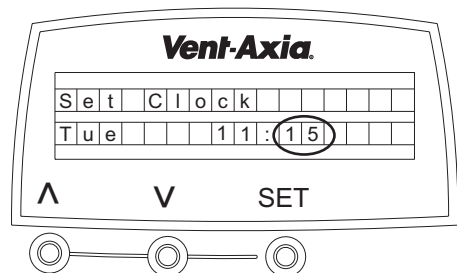

Note:

If you keep the 'Λ' or 'V' Key depressed for more than 2 seconds, the display will enter fast scroll mode.

AIR MINDER PLUS

4: ADJUSTING MEDIUM SPEED RUNNING TIME

4:1. Press the 'Λ' Key twice and the display will change from the default setting to the screen below:

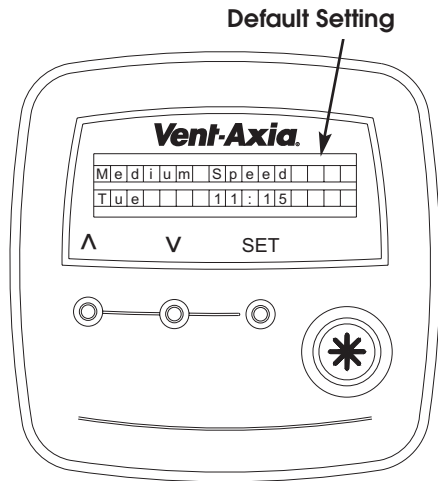
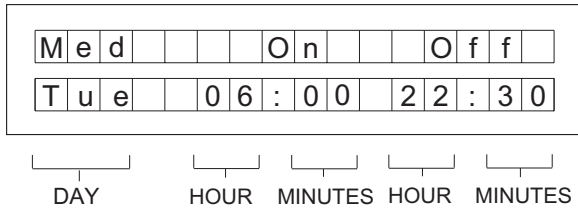

4:2. Selecting the Day to be adjusted.

Press the 'SET' Key and the day will start to flash. Press the 'Λ' or 'V' Key to select the day required, press the 'SET' Key again, the day will be set, and the on hour will start to flash.

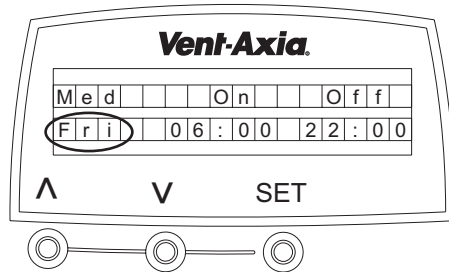

4:3. Setting the On Hour

Press the 'Λ' or 'V' Key to select the on hour, press the 'SET' Key again and the on hour will remain on and the on minutes will start to flash.

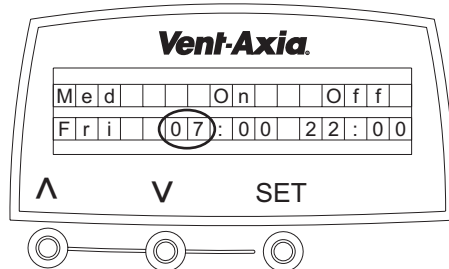

4:4. Setting the On Minutes

Press the 'Λ' or 'V' Key, to select the on minutes, press the 'SET' Key again and the on minutes will remain on and the off hour will start to flash.

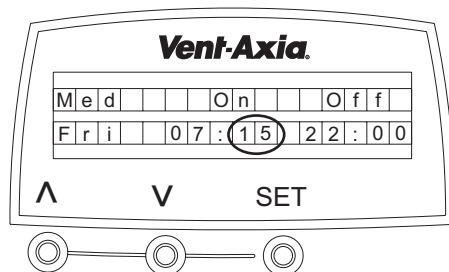

4:5. Setting the Off Hour

Press the 'Λ' or 'V' Key to select the off hour, press the 'SET' Key again and the off hour will remain on and the off minutes will start to flash.

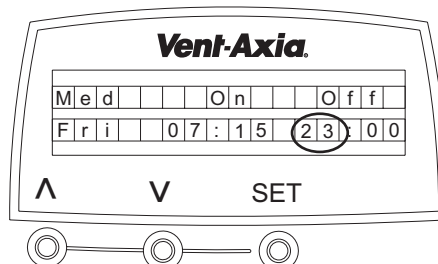

AIR MINDER PLUS

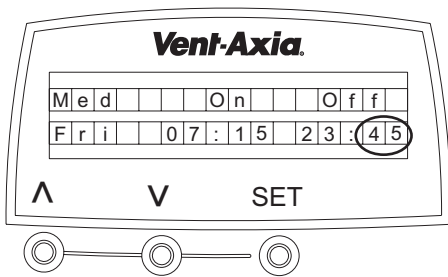

4:6. Setting the Off Minutes

Press the 'Λ' or 'V' Key, to select the off minutes, press the 'SET' Key again and the off minutes will remain on.

The on/off time settings are now complete

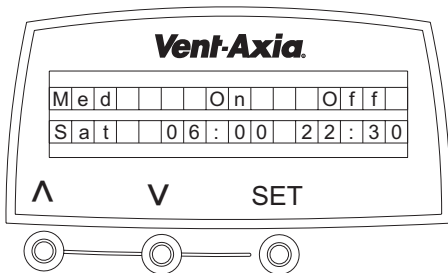

4:7. Selecting additional Days to be adjusted.

Press the 'SET' Key for the next day. Follow steps 4:3 to 4:6 to alter the Medium Speed Running time required for that day. Follow steps 4:3 to 4:7 for any additional days.

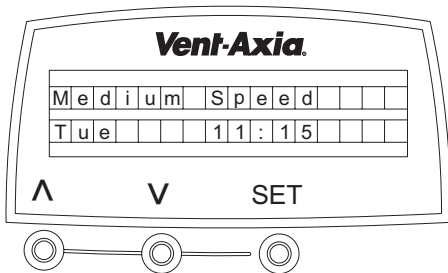

If no additional alterations are required, continue to press the 'SET' Key, until the normal running display appears (Medium or Low Speed will be displayed, depending on the time).

Note:

When the system is running in non default mode (the Medium Running times have been altered), an additional symbol (■) is displayed in the bottom right hand corner of the display.

Press the Boost Button (⊛) for 12 seconds to reset to daytime and night time default settings.

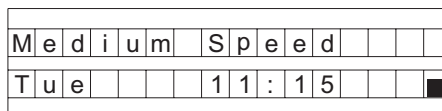

AIR MINDER PLUS

5: ADJUSTING THE SUMMER BYPASS INDOOR COMFORT LEVEL (THIS FACILITY IS ONLY AVAILABLE ON CERTAIN MODELS.)

- 5.1. Press the 'Λ' Key until the display changes to the screen below:
(Indoor Default temperature is set at 20°C).

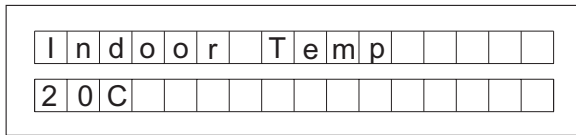

TEMPERATURE

- 5.2. **Selecting the Indoor Comfort Temperature.**

Press the 'SET' Key and the temperature will start to flash. Press the 'Λ' or 'V' Key and select the temperature required. The Indoor temperature is adjustable from 16°C to 30°C.

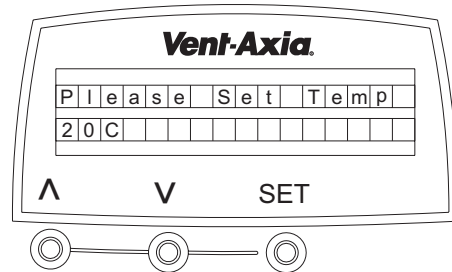
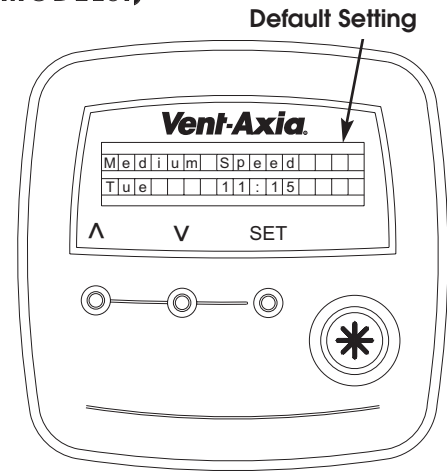

- 5.3. **Setting the Temperature.**

Press the 'SET' Key, the temperature will remain on and the display will change.

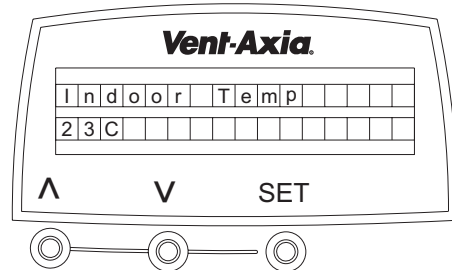

- 5.4. **Return to Normal Running**

The display will return to normal running after a short period of time, if no keys are pressed.

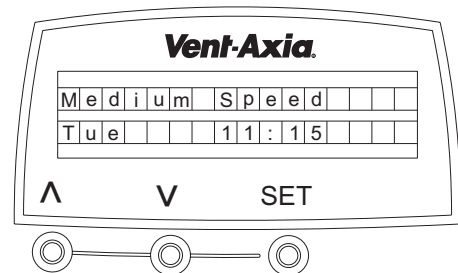

- 5.5. **Summer Bypass Active**

When the Summer Bypass is active, the top line of the display screen will alternate (for 10-second) between 'Summer Bypass On' or 'Med / Low Speed' (depending on day time or night time running).

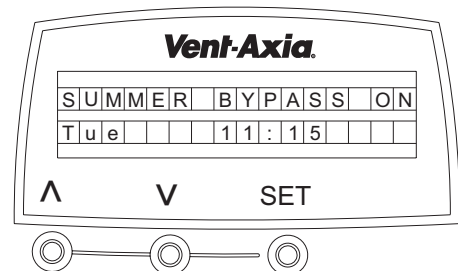

AIR MINDER PLUS

5.6. Winter Setting

To prevent the Summer By Pass facility activating during the Winter.

Press the 'V' 'Λ' and 'Set' keys for more than 5 seconds until the display changes to the screen opposite.

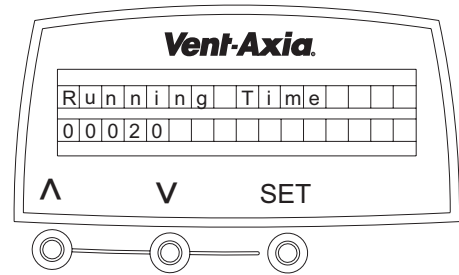

Press the 'Λ' until the display changes to the screen opposite.

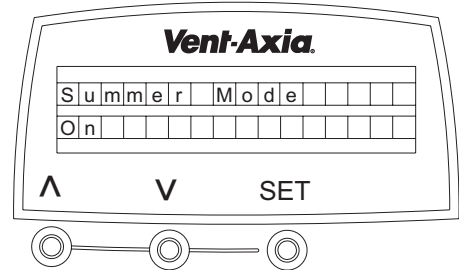

Press the 'Set' key until the display changes to the screen opposite.

Note the screen will return to its normal display after 20 seconds.

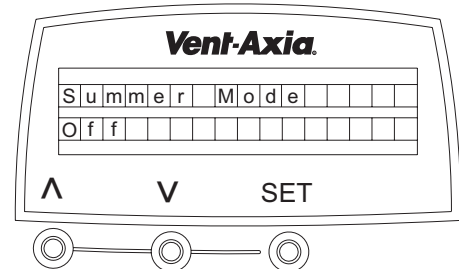

ROUTINE INSPECTION AND MAINTENANCE



WARNING:

THE FAN AND ANCILLARY CONTROL EQUIPMENT **MUST** BE ISOLATED FROM THE POWER SUPPLY PRIOR TO, AND DURING MAINTENANCE.

Air Filters

'Check Filter' display
(Alternates every 3 seconds with normal running screen).

An inspection of the Intake and Extract Filters are required on average every three months. An automatic timed reminder is flashed on the HRU's Controller.

When the unit is fitted to a new build property the Intake and Supply filters should be checked at one month intervals for the first six months.

1. Withdraw the filters as shown on page 2. **(Place in a large plastic bag and move to a safe working area).**
2. Using a vacuum cleaner remove any loose dust particles from the filter.
3. If further cleaning of the media is required, release the catches in the outer frame, remove the filter media and wash in warm soapy water.
4. Replace the filter media in the filter frame and allow it to dry.
5. Insert the filters back into the HRU.
6. To reset the automatic reminder on the Controller, press and hold the 'Λ' and 'V' Keys for 10 seconds.

Heat Recovery Cube

At intervals appropriate to the installation (e.g. Yearly), the Cube should be inspected and cleaned to ensure there is no build up of airborne contaminants.

1. Remove the Filters and Cube as shown on page 2. **(Place in a large plastic bag and move to a safe working area)**
2. Using a vacuum cleaner, remove any loose dust particles from the outside of the Cube.
3. Using a low pressure water hose, wash out the airways to remove any dust particles and allow to dry.
4. Replace the Cube and Filters (If applicable) as shown on page 2.

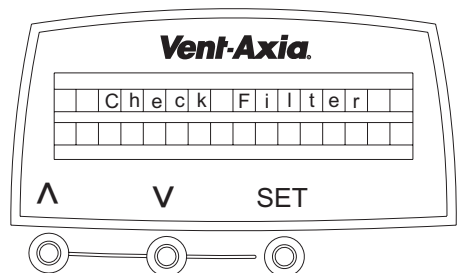

Vent-Axia®

As part of the policy of continuous product improvement Vent-Axia reserves the right to alter specifications without notice.



AIR MINDER PLUS LET YOUR HOME BREATHE

CONTACTS

Vent-Axia Limited
Fleming Way
Crawley
West Sussex
RH10 9YX

Tel: +44 (0) 1293 441535
Fax: +44 (0) 1293 539209

INTERNET SITE AT: www.vent-axia.com
EMAIL: info@vent-axia.com